

PA6-2.2V/XXXX

Body Worn Patch Antenna

Provisional Specification

The most important thing we build is trust.

Designed for security applications.

Designed for body worn applications.

Lightweight design.

Low profile design.

COBHAM

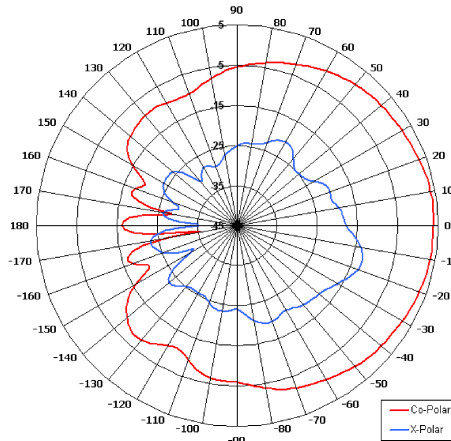

Azimuth Polar Plot (similar product)

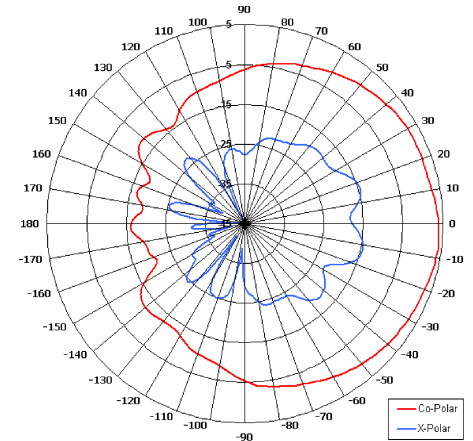

Elevation Polar Plot (similar product)

Front View

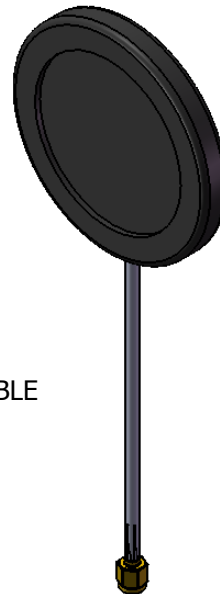
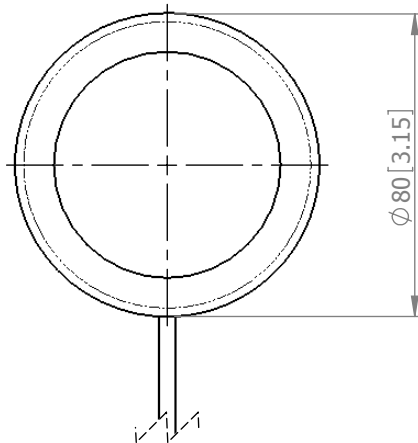

430mm OF RG316 CABLE SMA(M) CONNECTOR.

Base View

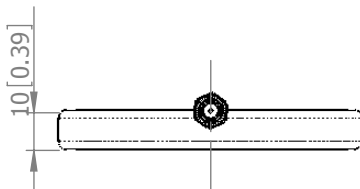

ELECTRICAL

Frequency:	2.2 - 2.4 GHz
Gain:	6 dBi Nom.
Polarisation:	Linear (Vertical)
Beamwidth:	70° (Az) x 70° (El)
Axial Ratio:	3 dB Typ.
VSWR:	2:1
Power Rating:	1 W
Front to Back:	20 dB
Electrical Tilt:	N/A

MECHANICAL

Standard Finish:	Matt Black
Mass:	TBD
Temperature:	-20° to +50°C
Wind Loading:	N/A

MOUNTING OPTIONS

Kits Available:	N/A
-----------------	-----

See Separate Data Sheets

GA: XXXX-X Issued: 120809
Dimensions: mm [inches] M (H,M,L)

European Antennas Limited trading as Cobham Antenna Systems, Microwave Antennas

European Antennas Limited has a policy of continuous development and stress that the information provided is a guide only and does not constitute an offer or contract or part thereof. Whilst every effort is made to ensure the accuracy of the information contained in this Data Sheet, no responsibility can be accepted for any errors or omissions.

The copyright of antenna designs and images is copyright protected and owned by European Antennas Limited.
©European Antennas Limited.

For further information please contact:

Cobham Antenna Systems, Microwave Antennas

Lambda House, Cheveley,
Newmarket, Suffolk. CB8 9RG, UK
Tel +44 (0) 1638 732177
Fax +44 (0) 1638 731999
Email antennasystems.ma@cobham.com